



DESIGN AND RATING

SHELL AND TUBE

HEAT EXCHANGERS

By John E. Edwards

Contents

- 1.0 Introduction**
- 2.0 Fundamentals**
 - 2.1 Basic Theory
 - 2.2 Heat Transfer Model Selection
- 3.0 Design Guidelines**

Appendices

- I Thermal Design Models Synopsis
- II CC-THERM User Guidelines
- III Thermal Model Selection
- IV Shortcut Heat Exchanger Design
- V TEMA Heat Exchanger Layout Designation
- VI Typical Overall Heat Transfer Coefficients
- VII Typical Resistance Fouling Coefficients
- VIII LMTD Correction Factor F_t
- IX Wolverine Tube General Details
- X Midland Wire Cordage Turbulator Details
- XI Tube Dimensional Data
- XII Shell Tube Count Data

References

1. Hewitt,G.F. et al (1994) Process Heat Transfer, (CRC Press)
 2. Perry,R.H. and Green, D. (1984) Perry's Chemical Engineers Handbook, 6th edition (McGraw Hill)
 3. Kern,D.Q. (1950) Process Heat Transfer (McGraw Hill)
 4. Coulson,J.M. and Richardson,J.F. (1993) Chemical Engineering Vol 1, 4th edition (Pergamon)
 5. Skinnet,R.K. (1993) Coulson & Richardson's Chemical Engineering Vol 6, 2nd edition (Pergamon)
 6. Chemstations,Inc. CHEMCAD THERM Version 5.1 User Guide
 7. Schlunder,E.U. (1993) VDI Heat Atlas (Woodhead Publishing)
 8. Seider,D.S., Seader,J.D.Seader and Lewin,R.L. Process Design Principles, (John Wiley & Sons, Inc.)
- [C20] References of this type are to be found in CC-THERM > Help > Appendix

1.0 Introduction

Shell and tube heat exchangers are used extensively throughout the process industry and as such a basic understanding of their design, construction and performance is important to the practising engineer.

The objective of this paper is to provide a concise review of the key issues involved in their thermal design without having to refer to the extensive literature available on this topic.

The author claims no originality but hopes that the format and contents will provide a comprehensive introduction to the subject and enable the reader to achieve rapid and meaningful results.

The optimum thermal design of a shell and tube heat exchanger involves the consideration of many interacting design parameters which can be summarised as follows:

Process

1. Process fluid assignments to shell side or tube side.
2. Selection of stream temperature specifications.
3. Setting shell side and tube side pressure drop design limits.
4. Setting shell side and tube side velocity limits.
5. Selection of heat transfer models and fouling coefficients for shell side and tube side.

Mechanical

1. Selection of heat exchanger TEMA layout and number of passes.
2. Specification of tube parameters - size, layout, pitch and material.
3. Setting upper and lower design limits on tube length.
4. Specification of shell side parameters – materials, baffle cut, baffle spacing and clearances.
5. Setting upper and lower design limits on shell diameter, baffle cut and baffle spacing.

There are several software design and rating packages available, including AspenBJAC, HTFS and CC-THERM, which enable the designer to study the effects of the many interacting design parameters and achieve an optimum thermal design. These packages are supported by extensive component physical property databases and thermodynamic models.

It must be stressed that software convergence and optimisation routines will not necessarily achieve a practical and economic design without the designer forcing parameters in an intuitive way. It is recommended that the design be checked by running the model in the rating mode.

It is the intention of this paper to provide the basic information and fundamentals in a concise format to achieve this objective.

The paper is structured on Chemstations CC-THERM software which enables design and rating to be carried out within a total process model using CHEMCAD steady state modelling software.

However the principles involved are applicable to any software design process.

In the Attachments a Design Aid is presented which includes key information for data entry and a shortcut calculation method in Excel to allow an independent check to be made on the results from software calculations.

Detailed mechanical design and construction involving tube sheet layouts, thicknesses, clearances, tube supports and thermal expansion are not considered but the thermal design must be consistent with the practical requirements.

Source references are not indicated in the main text as this paper should be considered as a general guidance note for common applications and is not intended to cover specialist or critical applications. Sources for this paper have been acknowledged where possible.

The symbols, where appropriate, are defined in the main text. The equations presented require the use of a consistent set of units unless stated otherwise.

2.0 Fundamentals

The basic layout for a countercurrent shell and tube heat exchanger together with the associated heat curve for a condensing process generated from CHEMCAD are shown below:

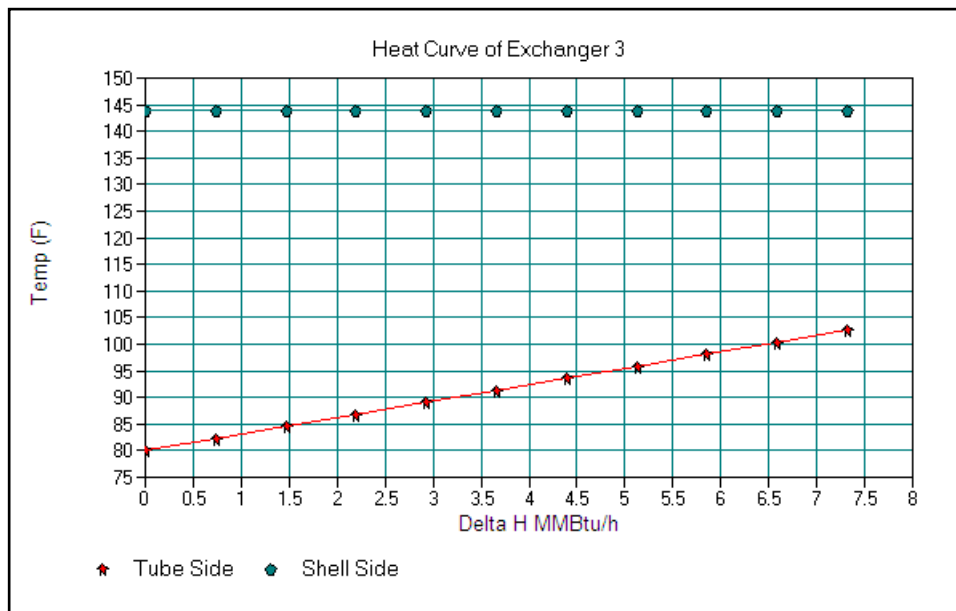
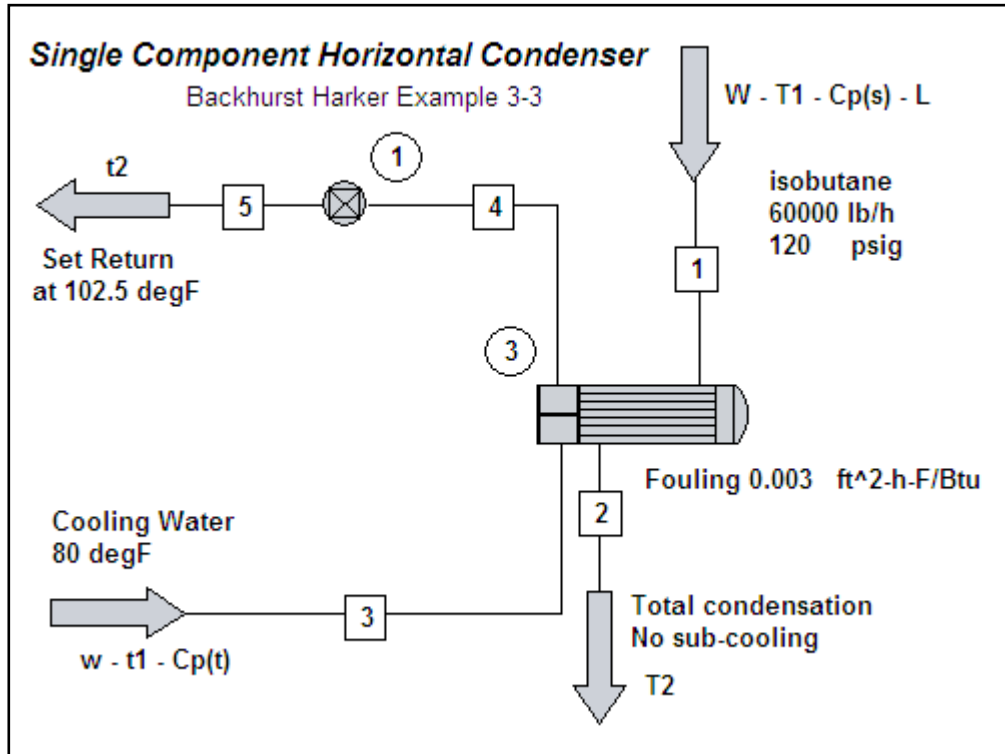

2.1 Basic Theory

The fundamental equations for heat transfer across a surface are given by:

$$Q = U A \Delta T_{lm} = w C_{p(t)}(t_2 - t_1) = W C_{p(s)}(T_1 - T_2) \quad \text{or} \quad W L$$

Where **Q** heat transferred per unit time (kJ/h, Btu/h)
U the overall heat transfer coefficient (kJ/h-m² °C, Btu/h-ft²-°F)
A heat-transfer area (m², ft²)
Δt_{lm} log mean temperature difference (°C, °F)
C_{p(t)} liquid specific heat tube side, **C_{p(s)}** liquid specific heat shell side (kJ/kg-°K, Btu/lb-°F)
w tube side flow **W** shell side flow (kg/h, lb/h)

The log mean temperature difference ΔT_{lm} (LMTD) for countercurrent flow is given by:

$$\Delta T_{lm} = \frac{(T_1 - t_2) - (T_2 - t_1)}{\ln \frac{(T_1 - t_2)}{(T_2 - t_1)}}$$

Where **T₁** inlet shell side fluid temperature
T₂ outlet shell side fluid temperature
t₁ inlet tube side temperature
t₂ outlet tube-side temperature

In design, a correction factor is applied to the LMTD to allow for the departure from true countercurrent flow to determine the true temperature difference.

$$\Delta T_m = F_t \Delta T_{lm}$$

The correction factor is a function of the fluid temperatures and the number of tube and shell passes and is correlated as a function of two dimensionless temperature ratios

$$R = \frac{(T_1 - T_2)}{(t_2 - t_1)} \quad S = \frac{(t_2 - t_1)}{(T_1 - t_1)}$$

Kern developed a relationship applicable to any heat exchanger with an even number of passes and generated temperature correction factor plots; plots for other arrangements are available in the TEMA standards.

The correction factor **F_t** for a 1-2 heat exchanger which has 1 shell pass and 2 or more even number of tube passes can be determined from the chart in the Appendix VIII and is given by:

$$F_t = \frac{(R^2 + 1)^{0.5} \ln [(1 - S)/(1 - RS)]}{(R - 1) \ln [(2 - S(R + 1 - (R^2 + 1)^{0.5})) / (2 - S(R + 1 - \sqrt{R^2 + 1}))]}$$

The overall heat transfer coefficient **U** is the sum of several individual resistances as follows:

$$\frac{1}{U} = \frac{1}{h_i} + \frac{1}{h_{fi}} + \frac{1}{k/x} + \frac{1}{h_o} + \frac{1}{h_{fo}}$$

The combined fouling coefficient **h_f** can be defined as follows:

$$h_f = \frac{h_{fi} h_{fo}}{h_{fi} + h_{fo}}$$

The individual heat transfer coefficients depend on the nature of the heat transfer process, the stream properties and the heat transfer surface arrangements. The heat exchanger layout depends on the heat transfer area (HTA) so an initial estimate is required based on a trial value of the OHTC.

CHEMCAD is used to establish the steady state mass and energy balances across the heat exchanger and typical values of the OHTC are shown in the Attachments. A quick calculation method XLTHERM is also available to assist this procedure. The fouling factors chosen can have a significant effect on the design and again typical values are shown in the Attachments.

2.2 Heat Transfer Model Selection

The heat transfer model selection is determined by the heat transfer process (sensible, condensing, boiling), the surface geometry (tube-side, shell-side), the flow regime (laminar, turbulent, stratifying, annular), and the surface orientation (vertical, horizontal).

A heat transfer model selection flow chart is presented in the Appendix IV to assist in this procedure. This flow chart indicates all the models available in CC-THERM and shows the default selections.

A synopsis of the various heat transfer models together with their conditions of application is given in Appendix I.

The key features of the models are summarised below:

Shellside Film Coefficient Methods for Single Component Condensation in Laminar Flow

The **Nusselt Method** is used for horizontal condensation under stratifying conditions where the liquid film is draining under gravity with minimum influence due to vapour shear. This is the CC-THERM default method.

The **Eissenberg Method** is applicable to condensation over tube banks and considers condensate layer thickening behaviour. This provides the most conservative heat transfer coefficient prediction as compared to the Nusselt and Kern methods for condensation over a single tube.

Range of application is for Reynolds Numbers to be in the range 1800 to 2000.

The Kern Method

Kern adapted the Nusselt equation to allow evaluation of fluid conditions at the film temperature.

This method requires the film to be in streamline flow with a Reynolds Numbers range 1800 to 2100.

Shellside Film Coefficient Methods for Single Component Condensation in Turbulent Flow

The **Colburn Method** is based on a correlation of industrial data for a wide range of fluids in heat exchangers using standard tube pitch designs.

Range of application is for Reynolds Numbers to be in the range 2000 to E06 gives results with a deviation +20% safe. It provides a good method for the verification of computer derived heat transfer coefficients.

The **McNaught Method** takes into account the effects of shear controlled heat transfer and the combination of gravity and shear effects. This is the CC-THERM default method.

Tubeside Film Coefficient Methods for Single Component Condensation

The Chaddock and Chato adaptation of the Nusselt Method

The method is applicable for gravity controlled condensation where the influence of vapour shear is low and we have a liquid film draining under gravity forming a stratified layer at the bottom of the tube

The Chemstations Method

This is based on Duckler (downflow) and Hewitt (upflow) adaptations to Deissler and von Karman equations. The method is applicable to condensation under shear controlled conditions for vertical and horizontal layouts under laminar or turbulent flow. The influence of gravity is negligible compared to the interfacial shear stress.

VDI Film Method

The Association of German Engineers (Verein Deutscher Ingenieure, VDI) have developed extensive methods for heat exchanger sizing based on a Heat Atlas method.

This method is available as an option in CC-THERM for condensation inside vertical tubes.

2.2 Heat Transfer Model Selection

Method for Multi-Component Condensation

Silver Bell Ghaly

The SBG method is based on the vapor phase condensing / cooling process following the equilibrium integral condensation curve which is met provided the Lewis Number **Le**, the ratio of **Sc** to **Pr**, is close to unity and all the heat released, including that from the liquid phase, passes from the interface to the coolant.

Deviations from equilibrium will result in errors in the prediction of vapor temperature. If heat is extracted more rapidly than equilibrium the vapor is super cooled or saturated which can lead to fog formation leading to possible pollution problems. If heat is extracted more slowly than equilibrium the vapor is superheated.

Tubeside Film Coefficient Methods for Sensible Heat Transfer in Laminar Flow

The **Seider Tate Equation** is applicable to horizontal and vertical pipes involving organic liquids, aqueous solutions and gases with a maximum deviation $\pm 12\%$. It is not conservative for water.

Range of application is for Reynolds Numbers to be in the range 100 to 2100

The **VDI-Mean Nusselt Method** is applicable to heat transfer behaviour involving tube banks. Correlation constants are available for applications with Reynolds Numbers in the range 10 to 2E06.

Tubeside Film Coefficient Methods for Sensible Heat Transfer in Turbulent Flow

The **Sieder Tate Equation (CC-THERM default)** is recommended when heating and cooling liquids involving large temperature differences and when heating gases in horizontal or vertical pipes with a maximum deviation $\pm 12\%$. It is not conservative for water.

Application to organic liquids, aqueous solutions and gases with Reynolds Number $Re > 10000$, Prandtl Number $0.7 < Pr < 700$ and $L/D > 60$ (e.g. for $L = 3$ ft, $D = 0.5$ in and $L = 4$ ft, $D = 0.75$), heating or cooling.

Colburn Method considers applications with varying heat transfer coefficient (U) by assuming the variation of U to be linear with temperature and by deriving an expression for the true temperature difference accordingly.

The **Dittus-Boelter Equation** is recommended for general use noting the standard deviation $\pm 12\%$. Applicable to both liquids and gases with Reynolds Number $Re > 10000$, Prandtl Number $0.7 < Pr < 160$ and $L/D > 10$ ie suitable for applications with shorter tube lengths.

Engineering Sciences Data Unit (ESDU) Method is applicable to both liquids and gases involving Reynolds Number $40000 < Re < 10^6$ and Prandtl Number $0.3 < Pr < 300$ this method gives more precise calculation. Though not mentioned in the text it is suggested that $L/D > 60$ be used. For Prandtl Numbers < 100 the Dittus-Boelter equation is adequate.

VDI-Mean Nusselt method determines the average heat transfer coefficient for the whole tube bank, as opposed to a single tube in cross-flow, and has been found to correlate with the maximum velocity between tubes rather than upstream velocity and is of more specific interest to heat exchanger designers.

3.0 Design Guidelines

References: Hewitt et al "Process Heat Transfer" p267, Kern "Process Heat Transfer" Chapter 7,p127 and Perry Section 11 p11-0 to p11-19

Definitions

Heat exchanger configurations are defined by the numbers and letters established by the Tubular Exchanger Manufacturers Association (TEMA). Refer to Appendix V for full details.

For example: A heat exchanger with a single pass shell and multi-pass tube is defined as a 1-2 unit. For a fixed tube-sheet exchanger with removable channel and cover, bonnet type rear head, one-pass shell 591mm (23¹/₄in) inside diameter with 4.9m(16ft) tubes is defined SIZE 23-192 TYPE AEL

Tube Diameter

The most common sizes used are 3/4"od and 1"od

Use smallest diameter for greater heat transfer area with a normal minimum of 3/4"od tube due to cleaning considerations and vibration. 1/2"od tubes can be used on shorter tube lengths say < 4ft.

The wall thickness is defined by the Birmingham wire gage (BWG) details are given in Appendix XI^(Kern Table 10)

Tube Number and Length

Select the number of tubes per tube side pass to give optimum velocity 3-5 ft/s (0.9-1.52 m/s) for liquids and reasonable gas velocities are 50-100 ft/s(15-30 m/s)

If the velocity cannot be achieved in a single pass consider increasing the number of passes.

Tube length is determined by heat transfer required subject to plant layout and pressure drop constraints. To meet the design pressure drop constraints may require an increase in the number of tubes and/or a reduction in tube length. Long tube lengths with few tubes may give rise to shell side distribution problems.

Tube Layout, Pitch and Clearance Definitions and Nomenclature

- B** baffle spacing(pitch)
- P_T** tube pitch
- C** clearance
- d_o** tube outside diameter
- D** shell inside diameter

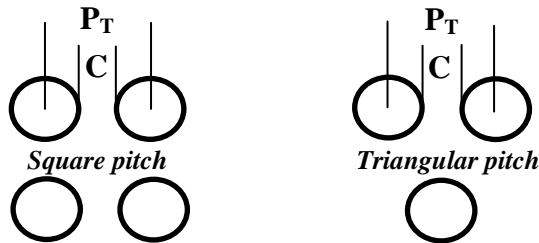

Tube pitch is defined as

$$P_T = d_o + C$$

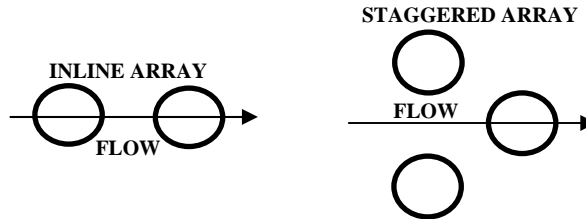

Triangular pattern provides a more robust tube sheet construction.
Square pattern simplifies cleaning and has a lower shell side pressure drop.
Typical dimensional arrangements are shown below, all dimensions in inches.

Tube od (in)	Square Pitch (in)	Triangular Pitch (in)
⁵ / ₈	⁷ / ₈ Note 1	²⁵ / ₃₂ Note 1
³ / ₄	1 Note 2	¹⁵ / ₁₆ or 1 Note 12
1	1 ¹ / ₄	1 ¹ / ₄
1 ¹ / ₄	1 ⁹ / ₁₆	1 ⁹ / ₁₆
1 ¹ / ₂	1 ⁷ / ₈	1 ⁷ / ₈

Note 1 For shell ≤12" pitch(square) ¹³/₁₆

Note 2 For shell ≤12" pitch(square) ¹⁵/₁₆

Table above uses minimum pitch 1.25 times tube diameter ie clearance of 0.25 times tube diameter.

Smallest pitch in triangular 30° layout for turbulent / laminar flow in clean service.

For 90° or 45° layout allow 6.4mm clearance for ³/₄ tube for ease of cleaning.

3.0 Design Guidelines

Shell Diameter

The design process is to fit the number of tubes into a suitable shell to achieve the desired shell side velocity 4ft/s(1.219m/s) subject to pressure drop constraints. Most efficient conditions for heat transfer is to have the maximum number of tubes possible in the shell to maximise turbulence.

Preferred tube length to shell diameter ratio is in the range 5 to 10.

Tube count data are given in Perry Table 11-3 where the following criteria have been used

- 1) Tubes have been eliminated to provide entrance area for a nozzle equal to 0.2 times shell diameter
- 2) Tube layouts are symmetrical about both the horizontal and vertical axes
- 3) Distance from tube od to centreline of pass partition 7.9mm(⁵/₁₆) for shell id <559mm (22in) and 9.5mm (³/₈) for larger shells.

Heat Transfer Area

Using the maximum number of tubes, subject to adequate provision for inlet nozzle, for a given shell size will ensure optimum shell side heat transfer in minimizing tube bundle bypassing.

The heat transfer area required design margin is then achieved by adjusting the tube length subject to economic considerations. On low cost tube materials it may be more economical to use standard lengths and accept the increased design margin.

It is a common practice to reduce the number of tubes to below the maximum allowed particularly with expensive tube material. In these situations the mechanical design must ensure suitable provision of rods, bar baffles, spacers, baffles to minimize bypassing and to ensure mechanical strength.

Baffle Design - Definitions

Shellside cross flow area a_s is given by

$$a_s = \frac{D C B}{P_T}$$

- Where
- D** shell i.d.
 - B** baffle spacing
 - C** clearance between tubes
 - P_T** tube pitch

Minimum spacing (pitch)

Segmental baffles normally should not be closer than 1/5th of shell diameter (ID) or 50.8mm(2in) whichever is greater.

Maximum spacing (pitch)

Spacing does not normally exceed the shell diameter.

Tube support plate spacing determined by mechanical considerations e.g. strength and vibration.

Maximum spacing is given by $B = 74 d_o^{0.75}$

Most failures occur when unsupported tube length greater than 80% TEMA maximum due to designer trying to limit shell side pressure drop. Refer to attachments.

Baffle cut

Baffle cuts can vary between 15% and 45% and are expressed as ratio of segment opening height to shell inside diameter. The upper limit ensures every pair of baffles will support each tube.

Kern shell side pressure drop correlations are based on 25% cut which is standard for liquid on shell side When steam or vapour is on the shell side 33% cut is used

Baffle pitch and not the baffle cut determines the effective velocity of the shell side fluid and hence has the greatest influence on shell side pressure drop.

Horizontal shell side condensation require segmental baffles with cut to create side to side flow

To achieve good vapour distribution the vapour velocity should be as high as possible consistent with satisfying pressure drop constraints and to space the baffles accordingly.

Baffle clearances

The edge distance between the outer tube limit (OTL) and the baffle diameter has to be sufficient to prevent tube breakthrough due to vibration. For example fixed tube-sheet clearances are shown below.

Refer to Perry p11-11 for floating head clearances.

Shell inside diameter mm (in)	Clearance shell id and OTL mm(in)
254(10) to 610(24)	11(⁷ / ₁₆)
≥ 635(25)	13(¹ / ₂)

3.0 Design Guidelines

Tube-sheet Layout (Tube Count) (Ref 4, page 577)

Bundle diameter D_b can be estimated using constants shown:

$$D_b = d_o (N_t / K_1)^{1/n}$$

Where d_o tube o.d.
 N_t number of tubes

Triangular Pitch $p_t = 1.25 d_o$					
Number Passes	1	2	4	6	8
K_1	0.319	0.249	0.175	0.0743	0.0365
n	2.142	2.207	2.285	2.499	2.675

Square Pitch $p_t = 1.25 d_o$					
Number Passes	1	2	4	6	8
K_1	0.215	0.156	0.158	0.0402	0.0331
n	2.207	2.291	2.263	2.617	2.643

Fouling Considerations

Typical fouling coefficients are shown in Appendix VII. It can be shown that the design margin achieved by applying the combined fouling film coefficient is given by:

$$\frac{A_f}{A_c} = 1 + \frac{U_c}{h_f}$$

where A_c is the clean HTA, A_f is the dirty or design HTA and U_c is the clean OHTC.

Results for Typical Fouling Coefficients (British Units)						
Fouling Resistances		Fouling Coefficients			Clean OHTC	Design Margin
Inside	Outside	Inside	Outside	Combined		
0.002	0.001	500	1000	333	50	1.15
0.002	0.001	500	1000	333	100	1.3
0.002	0.002	500	500	250	50	1.2
0.001	0.001	1000	1000	500	50	1.1

Corrosion Fouling

Heavy corrosion can dramatically reduce the thermal performance of the heat exchanger. Corrosion fouling is dependent on the material of construction selection and it should be possible to eliminate altogether with the right choice. However if economics determine that some corrosion is acceptable and no data is available from past experience an allowance of $1/16$ in (1.59 mm) is commonly applied.

Design Margin

The design margin to be applied to the design is based on the confidence level the designer has regarding the specific application and the future requirements for multipurpose applications. Design of condensers for multipurpose use, where a wide possible variation in flow conditions can exist, provides a particular problem in this regard.

It is standard practice to apply a design margin of 15% to the design (dirty) heat transfer area with the result that this is applied to the design margin resulting from the application of the fouling film coefficients discussed previously giving an added safety factor.

Pressure Drop ⁽⁸⁾

For process design using a simulation the following preliminary conservative estimates are given for pressure drops due to friction. Note an additional pressure change occurs if the exchanger is placed vertically.

Initial Process Design Pressure Drop Estimates		
Process Description	Pressure Drop (psi)	Pressure (kPa)
Liquid streams with no phase change	10	70
Vapor streams with no phase change	2	14
Condensing streams	2	14
Boiling streams	1	7

APPENDIX I HEAT TRANSFER MODEL SYNOPSIS

Shellside Film Coefficient Methods for Single Component Condensation in Laminar Flow

Horizontal condenser subcoolers are less adaptable to rigorous calculation but give considerably higher overall clean coefficients than vertical condenser subcoolers which have the advantage of well defined zones.

The Nusselt Method (Hewitt et al p590)[C20]

The mean heat transfer coefficient for horizontal condensation outside a single tube is given by the relationship developed by Nusselt. This correlation takes no account of the influence of vapour flow which, in addition to the effect of vapour shear, acts to redistribute the condensate liquid within a tube bundle.

$$h_o = 0.725 \left[\frac{k_L^3 \rho_L (\rho_L - \rho_G) g \lambda}{\mu_L d_o (T_{sat} - T_w)} \right]^{0.25}$$

The Kern Method (Kern p263)[S2]

Kern adapted the Nusselt equation to allow evaluation of fluid conditions at the film temperature

$$h_o = 0.943 \left[\frac{k_f^3 \rho_f^2 g \lambda}{\mu_f d_o \Delta t_f} \right]^{0.25}$$

For horizontal tube surfaces from 0° to 180° the above equation can be further developed to give

$$h_o = 0.725 \left[\frac{k_f^3 \rho_f^2 g \lambda}{\mu_f d_o \Delta t_f} \right]^{0.25}$$

McAdam extended the above equation to allow for condensate film and splashing affects where the loading per tube is taken to be inversely proportional to the number tubes to the power of 0.667.

$$h_o = 1.51 \left[\frac{k_f^3 \rho_f^2 g}{\mu_f^2} \right]^{0.33} \left[\frac{4W}{L N_t^{0.667} \mu_f} \right]^{-0.33}$$

This equation requires the film to be in streamline flow corresponding to Reynolds Numbers in range 1800 to 2100

The Eissenberg Method (Hewitt et al p660)[C20]

Horizontal shell side condensation involving multiple tubes in the presence of vapour is much more complex than the Nusselt single tube correlation, as the flow of condensate from one tube to another results in the condensate layer thickening on the lower tubes decreasing the heat transfer coefficient.

For a bank of n tubes the heat transfer coefficient determined by the Nusselt Method above is modified by the Eissenberg expression given below

$$h_n = h_o (0.6 + 0.42 n^{-0.25}) \text{ as compared with Kerns correction } h_n = h_o n^{-0.167}$$

The Eissenberg correction is more conservative than that due to Kern with Nusselt method being the most conservative ie the highest film coefficient.

Shellside Film Coefficient Methods for Single Component Condensation in Turbulent Flow

McNaught Method (Hewitt et al p661)[C21]

This method is probably the best available at the moment as it takes into account the effects of shear controlled heat transfer and the combination of gravity and shear effects.

**APPENDIX I
HEAT TRANSFER MODEL SYNOPSIS**

Tubeside Film Coefficient Methods for Single Component Condensation

Kern Modification of Nusselts equation (Perry 10-21, equation 10-105)

Laminar Flow

This stratified flow model represents the limiting condition at low condensate and vapor rates

Horizontal condensation inside tubes based on d_o
$$h_o = 0.815 \left[\frac{k_L^3 \rho_L (\rho_L - \rho_G) g \lambda}{\pi \mu_L d_o (T_{sat} - T_W)} \right]^{0.25}$$

Based on tube length L this can be shown to be
$$h_o = 0.761 \left[\frac{L k_L^3 \rho_L (\rho_L - \rho_G) g}{W_T \mu_L} \right]^{0.25}$$

Where W_T is total vapor condensed in one tube

A simplification can be made by setting $\rho_G = 0$ in the above correlations.

The Nusselt Method (Hewitt et al p594)

Chaddock and Chato adaptation for gravity stratifying flow

For horizontal condensation inside tubes there are two extreme cases

- 1) Gravity controlled where the influence of vapour shear is low and we have a liquid film draining under gravity forming a stratified layer at the bottom of the tube
- 2) Shear controlled where a uniform annular film is formed. The influence of gravity is negligible compared to the interfacial shear stress.

For horizontal condensation under stratifying conditions (case 1) the mean coefficient for the whole circumference is given by

$$h_o = 0.72 \epsilon_G^{0.75} \left[\frac{k_L^3 \rho_L (\rho_L - \rho_G) g h_{Lg}}{\mu_L d_o (T_{sat} - T_W)} \right]^{0.25}$$

The Chemstations Method (Hewitt et al p580-p589 and Perry 10-21)[C23]

Duckler (downflow) and Hewitt (upflow) adaptations to Deissler and von Karman equations

For condensation under shear controlled conditions for vertical and horizontal conditions the methods for laminar and turbulent flow uses the following procedure for determining the heat transfer coefficient can be summarised :

- a) The interfacial shear stress is calculated.
- b) The condensate flow per unit periphery and the Reynolds Number for the liquid film Re_f is calculated.
- c) Estimate δ^* which is a function of Re_f and τ_δ^+ which is a function of the liquid Prandtl Number Pr_L

e) Calculate the local liquid film heat transfer coefficient from the following relationship
$$h_i = \frac{C_{pL} (\rho_L \tau_o)^{0.5}}{\tau_\delta^+}$$

An alternative and more simple method due to Boyko and Kruzhilin is available but not used in CC-THERM

Boyko and Kruzhilin adaptation of the Mikheev correlation

Vertical condensation inside tubes Mikheev correlation
$$h_{LO} = 0.021 \frac{k_L}{d} (Re)_{LO}^{0.8} (Pr)_L^{0.43}$$

Boyko and Kruzhilin equation
$$h_i = h_{LO} \left[1 + x \left(\frac{\rho_L}{\rho_G} - 1 \right) \right]^{0.5}$$
 where x is mean of end values

APPENDIX I HEAT TRANSFER MODEL SYNOPSIS

Tubeside Film Coefficient Methods for Single Component Condensation

VDI Film Method (VDI Heat Atlas 1992 pJa6- pJa8) [C24]

The Association of German Engineers (Verein Deutscher Ingenieure, VDI) have developed extensive methods for heat exchanger sizing based on a Heat Atlas method.

This method is available as an option in CC-THERM for condensation inside vertical tubes.

Method for Multi-Component Condensation

Silver Bell Ghaly (SBG) (Hewitt et al p635-p636) [C1] [C2]

The SBG method is based on the following assumptions

Vapor phase condensing / cooling follows the equilibrium integral condensation curve (i.e., $T_v = T_E$)

This condition is met provided the Lewis Number Le is close to unity, where

$$Le = Sc / Pr$$

All the heat released, including that from the liquid phase passes from the interface to the coolant

The heat transfer dQ in an increment of exchanger area comprises heat extracted due to latent heat dQ_L and sensible heat in the gas dQ_G and liquid dQ_L phases giving

$$dQ = dQ_L + dQ_L + dQ_G = U^i (T_i - T_C) dA$$

The flux of sensible heat from the vapor is given by

$$\frac{dQ_G}{dA} = h_G (T_E - T_i)$$

We define a parameter Z where

$$Z = \frac{dQ_G/dA}{dQ/dA} = \frac{dQ_G}{dQ}$$

Combining with the above we can show

$$A = \int_0^{Q_T} \frac{(1 + Z U^i / h_G) dQ}{U^i (T_E - T_C)}$$

Deviations from equilibrium will result in errors in the prediction of vapor temperature. If heat is extracted more rapidly than equilibrium leads to the vapor temperature being less than T_E the vapor is super cooled or saturated which can lead to fog formation leading to possible pollution problems. If heat is extracted more slowly than equilibrium giving a vapor temperature greater than T_E the vapor is superheated.

APPENDIX I HEAT TRANSFER MODEL SYNOPSIS

Tubeside Film Coefficient Methods for Sensible Heat Transfer in Laminar Flow

Seider-Tate Equation (Kern p103)

Application $100 < Re < 2100$ in heating or cooling applications and in horizontal / vertical pipes involving organic liquids, aqueous solutions and gases with maximum deviation $\pm 12\%$. It is not conservative for water.

$$Nu = 1.86 \left[(Re) (Pr) \left(\frac{d}{L} \right) \right]^{0.33} \left(\frac{\mu_B}{\mu_W} \right)^{0.14}$$

Tubeside Film Coefficient Methods for Sensible Heat Transfer in Turbulent Flow

Seider-Tate Equation (Perry 10-16)[S1]

Sieder-Tate applies a viscosity correction factor when heating/cooling liquids with large temperature differences or when heating gases as heat transfer is reduced (ie $T_B/T_W < 1$). Correction is not required when cooling gases even with large temperature differences.

Application to organic liquids, aqueous solutions and gases with Reynolds Number $Re > 10000$, Prandtl Number $0.7 < Pr < 700$ and $L/D > 60$ (e.g. for $L=3$ ft, $D=0.5$ in and $L >= 4$ ft, $D >= 0.75$), heating or cooling and horizontal / vertical pipes with maximum deviation $\pm 12\%$. It is not conservative for water.

$$Nu = 0.023 Re^{0.8} Pr^{0.33} \left(\frac{\mu_B}{\mu_W} \right)^{0.14} \quad (\text{Note Kern p103 uses } 0.027)$$

Colburn Method (Hewitt et al p105) [S2]

Applying the analogy between heat transfer and friction to the friction factor for turbulent flow gives

$$f_0 = 0.046 Re^{0.2}$$

The Colburn equation for turbulent heat transfer in smooth pipes is derived

$$Nu = (f_0/2) Re Pr^{0.33} = 0.023 Re^{0.8} Pr^{0.33}$$

Colburn also developed a method (Kern p 94 and Fig17) for applications with varying heat transfer coefficient (U) by assuming the variation of U to be linear with temperature and by deriving an expression for the true temperature difference accordingly.

Dittus-Boelter Equation (Hewitt et al p105)[S2]

Application to both liquids and gases with Reynolds Number $Re > 10000$, Prandtl Number $0.7 < Pr < 160$ and $L/D > 10$ (ie less stringent than Sieder-Tate above)

This is recommended for general use bearing in mind standard deviation error of $\pm 13\%$

$$Nu = 0.023 Re^{0.8} Pr^n \quad \text{where } n = 0.4 \text{ for heating and } n = 0.3 \text{ for cooling}$$

Engineering Sciences Data Unit (ESDU) Method (Hewitt et al p 105)

Application to both liquids and gases with Reynolds Number $40000 < Re < 10^6$ and Prandtl Number $0.3 < Pr < 300$ this method gives more precise calculation. Though not mentioned in the text it is suggested that $L/D > 60$ be used. For Prandtl Numbers < 100 the Dittus-Boelter equation is adequate.

$$Nu = 0.0225 Re^{0.795} Pr^{0.495} \exp \left[-0.0225 (\ln Pr)^2 \right]$$

**APPENDIX I
HEAT TRANSFER MODEL SYNOPSIS**

**Tubeside Film Coefficient Methods for Sensible Heat Transfer in Turbulent Flow
VDI-Mean Nusselt (Hewitt et al p 73-79)[S19]**

This method determines the average heat transfer coefficient for the whole tube bank, as opposed to a single tube in cross-flow, and has been found to correlate with the maximum velocity between tubes rather than upstream velocity and is of more specific interest to heat exchanger designers.

Most cross-flow tube banks are arranged either in in-line arrays or staggered arrays as shown below

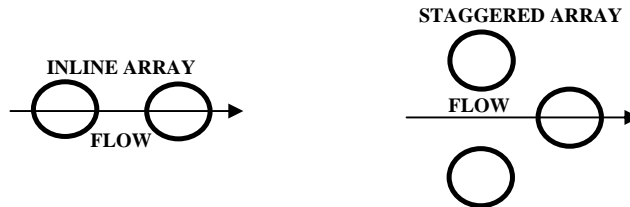

The correlation takes the form

$$\mathbf{Nu} = \mathbf{a} \mathbf{Re}^{\mathbf{m}} \mathbf{Pr}^{0.34} \mathbf{F}_1 \mathbf{F}_2$$

- where **Nu** is the mean Nusselt Number
- Re** is the Reynolds Number is based on the maximum flow velocity
- V_{max}** Reynolds Number is calculated using **V_{max}** formulae given in Hewitt Table 2.4 p76
- a** and **m** correlation constants
- F₁** and **F₂** correction factors for surface to bulk physical property variations and for the effect of the number of tube rows in the array respectively where **F₁** is given by

$$\mathbf{F}_1 = \left(\frac{\mathbf{Pr}_B}{\mathbf{Pr}_W} \right)^{0.26}$$

This relationship is valid for **Pr** < 600 and **Re** > 10

Where the number of cross-flow tube rows **n_r** > 10 **F₂** ≅ 1 and for **n_r** = 4 **F₂** ≅ 0.9

Values of **a** and **m** correlation constants for **p₁/D = 1.2 to 4** and **P₂/D ≥ 1.15** are as shown Refer to Hewitt Table 2.4 p76 for further details re tube bank layouts.

Reynolds Number	In-Line Banks		Staggered Banks	
	a	m	a	m
10 to 300	0.742	0.431	1.309	0.360
300 to 2.0 E05	0.211	0.651	0.273	0.635
2.0 E05 to 2.0 E06.	0.116	0.700	0.124	0.700

APPENDIX I HEAT TRANSFER MODEL SYNOPSIS

Shellside Film Coefficient Methods for Sensible Heat Transfer in Turbulent Flow

Stream Analysis (CC-THERM default)

This method balances the pressure drop across the baffles for each of the possible flow paths. These include the spaces between the tube od and the baffle hole, between the shell id and the OTL, shell id and baffle od, pass clearance lanes and across the tube bundle.

Bell-Delaware Method (Hewitt et al p 275 to p 277)

This method incorporates correction factors for the following elements

1. Leakage through the gaps between the tubes and the baffles and the baffles and the shell.
2. Bypassing of the flow around the gap between the tube bundle and the shell
3. Effect of the baffle configuration recognising that only a fraction of the tubes are in pure cross flow.
4. Effect of adverse temperature gradient on heat transfer in laminar flow ($Re < 100$) but is considered of doubtful validity.

The first step is to calculate the ideal cross flow heat transfer coefficient using the VDI-Mean Nusselt. The maximum velocity is calculated using flow area calculations depending on tube layout and pitch, baffle spacing, shell diameter and tube bundle diameter. Correction factors are applied to the calculated heat transfer coefficient for baffle configuration, for leakage related to shell to baffle and tube to baffle, and for bypass in the bundle to shell gap.

Kern Method due to Colburn (Kern p137)

Based on a correlation of industrial data for hydrocarbons, organic compounds, water and aqueous solutions and gases when the bundle employs baffles having acceptable clearances between baffles/tubes and baffles/shell and tube pitches (in) shown below.

Range of application is for Reynolds Number $2000 < Re < 10^6$ gives results with deviation +20% ie safe

Tube od (in)	Square Pitch (in)	Triangular Pitch (in)
$\frac{3}{4}$	1	$\frac{15}{16}$ or 1
1	$1\frac{1}{4}$	$1\frac{1}{4}$
$1\frac{1}{4}$	$1\frac{9}{16}$	$1\frac{9}{16}$
$1\frac{1}{2}$	$1\frac{7}{8}$	$1\frac{7}{8}$

$$Nu = 0.36 Re^{0.55} Pr^{0.33} \left(\frac{\mu_B}{\mu_W} \right)^{0.14}$$

APPENDIX I HEAT TRANSFER MODEL SYNOPSIS

Shellside Film Coefficient Methods for Single Component Condensation in Laminar Flow

Horizontal condenser subcoolers are less adaptable to rigorous calculation but give considerably higher overall clean coefficients than vertical condenser subcoolers which have the advantage of well defined zones.

The Nusselt Method (Hewitt et al p590)[C20]

The mean heat transfer coefficient for horizontal condensation outside a single tube is given by the relationship developed by Nusselt. This correlation takes no account of the influence of vapor flow which, in addition to the effect of vapor shear, acts to redistribute the condensate liquid within a tube bundle.

$$h_o = 0.725 \left[\frac{k_L^3 \rho_L (\rho_L - \rho_G) g \lambda}{\mu_L d_o (T_{sat} - T_w)} \right]^{0.25}$$

The Kern Method (Kern p263)[S2]

Kern adapted the Nusselt equation to allow evaluation of fluid conditions at the film temperature

$$h_o = 0.943 \left[\frac{k_f^3 \rho_f^2 g \lambda}{\mu_f d_o \Delta t_f} \right]^{0.25}$$

For horizontal tube surfaces from 0° to 180° the above equation can be further developed to give

$$h_o = 0.725 \left[\frac{k_f^3 \rho_f^2 g \lambda}{\mu_f d_o \Delta t_f} \right]^{0.25}$$

McAdam extended the above equation to allow for condensate film and splashing affects where the loading per tube is taken to be inversely proportional to the number tubes to the power of 0.667.

$$h_o = 1.51 \left[\frac{k_f^3 \rho_f^2 g}{\mu_f^2} \right]^{0.33} \left[\frac{4W}{L N_t^{0.667} \mu_f} \right]^{-0.33}$$

This equation requires the film to be in streamline flow corresponding to Reynolds Numbers in range 1800 to 2100

The Eissenberg Method (Hewitt et al p660)[C20]

Horizontal shell side condensation involving multiple tubes in the presence of vapor is much more complex than the Nusselt single tube correlation, as the flow of condensate from one tube to another results in the condensate layer thickening on the lower tubes decreasing the heat transfer coefficient.

For a bank of n tubes the heat transfer coefficient determined by the Nusselt Method above is modified by the Eissenberg expression given below

$$h_n = h_o (0.6 + 0.42 n^{-0.25}) \text{ as compared with Kerns correction } h_n = h_o n^{-0.167}$$

The Eissenberg correction is more conservative than that due to Kern with Nusselt method being the most conservative ie the highest film coefficient.

Shellside Film Coefficient Methods for Single Component Condensation in Turbulent Flow

McNaught Method (Hewitt et al p661)[C21]

This method is probably the best available at the moment as it takes into account the effects of shear controlled heat transfer and the combination of gravity and shear effects.

APPENDIX II CC-THERM USER GUIDELINES

Design Optimisation

CC-THERM always searches from a small size to a large size which ensures the minimum possible excess area consistent with satisfying the user specified shell side and tube side pressure drop and velocity design constraints.

If design is pressure drop or velocity limited leading to an oversized area the user can relax the pressure drop and/or the velocity design constraint and possibly adjust tube pitch or diameter to make the design a heat transfer area limited design.

CC-THERM issues a message at the end of its search advising if the design is pressure drop, velocity or area limited to assist in the optimization process.

The heat exchanger design can be forced by setting design limits to constrain certain parameters. For example restricting tube length to meet an installation constraint will result in an increase in the number of tubes and hence shell diameter. Standard shell sizes are used so an increase in diameter from 8" to 10" could lead to an oversize of 56% derived from the increase in shell area ratio.

To achieve final design optimisation the user should switch to the rating mode and adjust tube length until the desired area safety margin has been achieved.

Tube Counts

For a selected shell diameter, tube design parameters (diameter, pitch, layout) and clearances there is a limit to the number of tubes that can fit determined by the outer tube limits (OTL).

Standard tube count tables are provided in Perry Table 11-3 and CC-THERM will always use these values if standard tube sizes are specified in Imperial units.

If the design is based on Metric units the user should ensure a practical design has been achieved in regards to tube counts. The table value can be achieved by entering the Imperial size exactly in Metric e.g. $\frac{3}{4}$ " entered as 19.05mm not 19mm.

LMTD

When running UnitOp HEATEX in CHEMCAD the LMTD is based on the inlet and outlet temperatures.

CC-THERM LMTD is based on a zone by zone computation resulting in an overall LMTD being a weighted mean average by zone heat load hence the two values will be different.

Heat Exchanger Layout

When specifying multiple pass configurations in CHEMCAD UnitOp HEATEX this information is not passed on to CC-THERM; the user needs to re-enter this information.

User Specified Components

For a new component the designer is normally provided with physical properties at the inlet and outlet conditions only. Pure regression can be carried out using two data points only for viscosity, specific heat and thermal conductivity.

Density regressions will sometimes require forcing (set weighting at high value e.g. 10^6 for a given data point) or to change the library equation in the density parameter to a simpler form e.g. linear between close limits and set the data limit values.

Nomenclature
D shell diameter
d_o tube outside diameter
B baffle spacing
P_T tube pitch
C clearance
 Where $P_T = d_o + C$

Using CHEMCAD perform
 Steady State
 Mass and Energy Balances

Appendix II
 Therm User Guidelines

Using CC-THERM specify
 Type, tube size, tube layout, material
 Assign fluids to shell or tube side

Shortcut design method
 Estimate heat transfer coefficients
 Calculate area required

Specify thermal design criteria
 Shell and tube side heat transfer model
 Shell and tube side fouling coefficients

Set tube size, length, layout
 Calculate number of tubes
 Estimate shell diameter

Specify key design criteria
 Shell and tube side dp allowable
 Shell and tube side velocity allowable

Set baffle cut and spacing
 Check shell side velocity
 Check tube side velocity

$B \geq 0.2 D/50$
 $B \leq D$ or $74d^{0.75}$
 Cut 15to45%

Decide upper and lower design limits
 Tube length and shell diameter
 Baffle cut and spacing

L/D 5 to 10
 $P_T \geq 1.25 d_o$

Using CC-THERM calculate
 Number of tubes and shell diameter
 Confirm optimization process valid

Check CC-THERM results for validity
 Heat transfer coefficients, design margin
 Tube, shell and baffle details

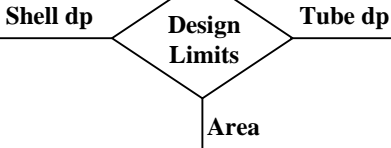

Optimize for shell dp specification
 1 Shell diameter limit not constraining
 2 Adjust baffle cut, spacing, tube pitch

Optimize for design margin required
 1 Set shell diameter adjust tube length
 2 Set tube length adjust pitch or shell

Optimize for tube dp specification
 1 Adjust tube length, diameter, passes
 2 Shell diameter limit not constraining

Using CC-THERM optimize design
 Validate with shortcut techniques
 Document and plot results

CC-THERM
DEFAULT
MODE

Appendix III
Therm Model Selection

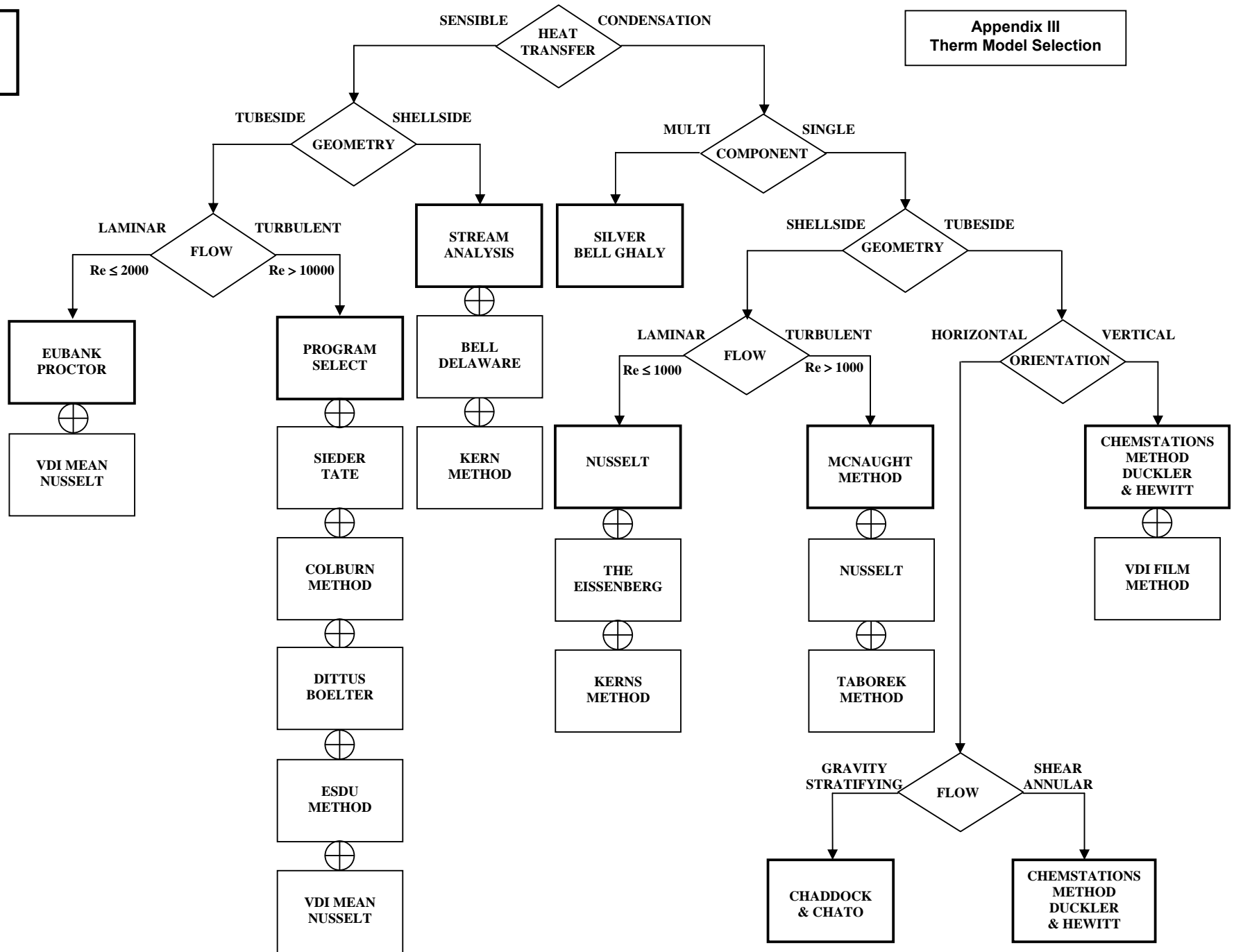

**APPENDIX IV
SHORTCUT HEAT EXCHANGER DESIGN**

Shell & Tube Heat Exchanger Shortcut Design

Version 6.0









HEAT EXCHANGER DIMENSIONS		UNITS
DESCRIPTION	PARAMETERS	British
Tube OD	0.7500	IN
Tube Length	16.0000	FT
Pitch Type	Square	
Pitch	1.0000	IN
TEMA Type	L or M	
Number of TS Passes	2	
Thermal Duty	7320000.0	Btu/h
Design U	90	Btu / FT ² h F
LMTD	51.74	F
Design Area	1571.96	FT ²
Design Margin	0.00	%
Service U	90	Btu / FT ² h F
Effective Area	1571.96	FT ²
Number Tubes	500	Dimensionless
Tube Bundle Diameter	25	IN
Shell Diameter	27.01	IN

Project:	Backhurst Harker Example 3-3
Process:	isobutane / water
Operation:	Condensation
Document:	Horizontal Condenser BH3-3
Signatory:	J.E.Edwards
Issue:	A
Date:	30-Aug-08

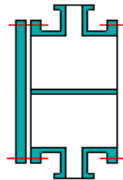
Manual Data Entry
Calculation
Design Selection

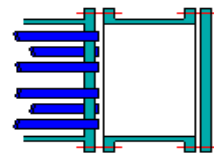
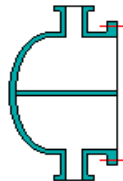
TUBESIDE CONDENSING VELOCITY ESTIMATES			SHELLSIDE CONDENSING VELOCITY ESTIMATES		
DESCRIPTION	PARAMETERS	UNITS	DESCRIPTION	PARAMETERS	UNITS
Fluid Name	Water		Fluid Name	isobutane	
Molecular Weight	18.01	kg/kg mol	Molecular Weight	58.12	kg/kg mol
Boiling Point	100	DEG C	Boiling Point	-11.72	DEG C
Operating Temperature	26.7	DEG C	Operating Temperature	62.16	DEG C
Operating Pressure	2.07	bar	Operating Pressure	9.287	bar
Vapour Density	1.4947	kg/M ³	Vapour Density	19.36	kg/M ³
Liquid Density	996.3	kg/M ³	Liquid Density	501.57	kg/M ³
Total Flowrate	146501.6	kg/h	Total Flowrate	27215.5	kg/h
Vapor Fraction	0	w/w	Vapor Fraction	1	w/w
Vapor Flowrate	0	kg/h	Vapor Flowrate	27215.5	kg/h
Inlet Vapour Velocity	0.00	M/s	Minimum Baffle Spacing	2.0	IN
Outlet Liquid Velocity	0.573	M/s	Baffle Spacing Selected	12.0	IN
			Tube Pitch	1	IN
			Minimum Clearance	0.25	IN
			Crossflow Area	0.0492	M ²
			Vapor Velocity	7.93	M/s
SHELLSIDE LIQUID VELOCITY ESTIMATES			TUBESIDE LIQUID VELOCITY ESTIMATES		
DESCRIPTION	PARAMETERS	UNITS	DESCRIPTION	PARAMETERS	UNITS
Fluid Name	isobutane		Fluid Name	Water	
Liquid Density	501.57	kg/M ³	Inlet Density	995	kg/M ³
Flowrate	27215.5	kg/h	Flowrate	146501.6	kg/h
Minimum Baffle Spacing	1.968	IN	Number of TS Passes	2	Dimensionless
Baffle Spacing Selected	12.0	IN	Inlet Liquid Velocity	0.574	M/s
Tube Pitch	1	IN			
Minimum Clearance	0.25	IN			
Crossflow Area	0.0492	M ²			
Mean Velocity	0.3062	M/s			

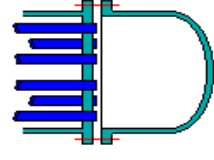
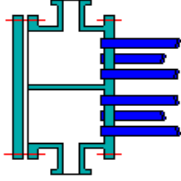
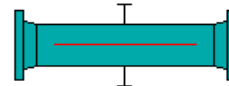
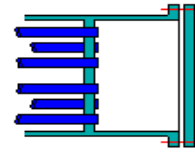
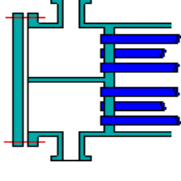
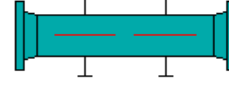
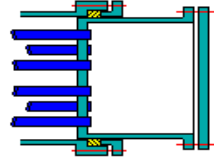
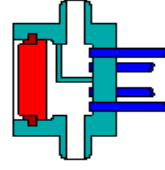
**APPENDIX V
TEMA HEAT EXCHANGER LAYOUT DESIGNATION**

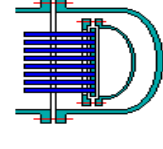
Front End Stationary Head Types	Shell Types	Rear End Head Types
A Channel and Removeable Cover	E One Pass Shell	L Fixed Tubesheet Stationary Head
		
B Bonnet (Integral Cover)	F Two Pass Shell with Longitudinal Baffle	M Fixed Tubesheet Stationary Head
		
C Channel Integral with Tubesheet and Removeable Cover	G Split Flow	N Fixed Tubesheet Stationary Head
		
D Channel Integral with Tubesheet and Removeable Cover	H Double Split Flow	P Outside Packed Floating Head
		
Special High Pressure Closure	J Divided Flow	S Floating Head with Backing Device
		

**APPENDIX V
TEMA HEAT EXCHANGER LAYOUT DESIGNATION**

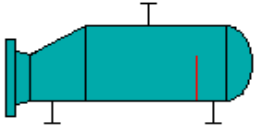
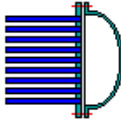
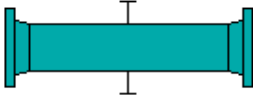
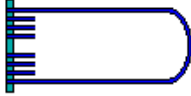
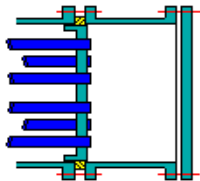
K	T
Kettle Type Reboiler	Pull Through Floating Head
	
X	U
Cross Flow	U-Tube Bundle
	
W	
Externally Sealed Floating Tubesheet	
	

TEMA CLASS	APPLICATION
R	Severe requirements of petroleum and related process applications
C	Moderate requirements of commercial and general process applications
B	Chemical process service

APPENDIX VI
TYPICAL OVERALL HEAT TRANSFER COEFFICIENTS

TYPICAL OVERALL HEAT TRANSFER COEFFICIENTS (fouling~0.003 ft ² hdegF/Btu)				Units	U Btu/ h ft ² degF ▼
Fouling	Inside (Btu/ft ² hdegF) 2000 ▼	Outside (Btu/ft ² hdegF) 2000 ▼	Typical OHTC		
Application	Hot fluid	Cold fluid	Minimum	Maximum	
Heat exchangers	Water	Water	141	264	
	Aqueous solutions	Aqueous solutions(1)	250	500	
	Organic solvents	Organic solvents	18	53	
	Light oils	Light oils	18	70	
	Medium organics	Medium organics (1)	20	60	
	Heavy organics	Light organics(1)	30	60	
	Heavy organics	Heavy organics(1)	10	40	
	Light organics	Heavy organics(1)	10	40	
	Gases	Gases	2	9	
Coolers	Water	Water (1)	250	500	
	Methanol	Water (1)	250	500	
	Organic solvents	Water	44	132	
	Aqueous solutions	Water(1)	250	500	
	Light oils	Water	62	158	
	Medium organics	Water(1)	50	125	
	Heavy oils	Water	11	53	
	Gases	Water	4	53	
	Organic solvents	Brine	26	88	
	Water	Brine	106	211	
	Gases	Brine	3	44	
Heaters	Steam	Water	264	704	
	Steam	Aqueous solutions <2.0 cp (1)	200	700	
	Steam	Aqueous solutions >2.0 cp (1)	100	500	
	Steam	Organic solvents	88	176	
	Steam	Light organics/oils	53	158	
	Steam	Medium organics (1)	50	100	
	Steam	Heavy organics/oils	11	79	
	Steam	Gases	5	53	
	Dowtherm	Heavy oils	9	53	
	Dowtherm	Gases	4	35	
	Flue gases	Steam	5	18	
	Flue	Hydrocarbon vapors	5	18	
Condensers	Aqueous vapors	Water	176	264	
	Organic vapors	Water	123	176	
	Organics with non-condensibles	Water	88	123	
	Vacuum condensers	Water	35	88	
Vaporisers	Steam	Aqueous solutions	176	264	
	Steam	Light organics	158	211	
	Steam	Heavy organics	106	158	

**APPENDIX VII
TYPICAL FOULING RESISTANCE COEFFICIENTS**

COOLING WATER FOULING RESISTANCES/COEFFICIENTS					
Hot Fluid Temperature		Up to 240 °F		240 to 400 °F	
Water	Temperature	Up to 125 °F		Over 125 °F	
	Velocity	Up to 3 ft/s	Over 3 ft/s	Up to 3 ft/s	Over 3 ft/s
	Unit Select	Resistance ft ² h°F / Btu			
Boiler Blowdown		2.00E-03	2.00E-03	2.00E-03	2.00E-03
Boiler Feed (Treated)		1.00E-03	5.00E-04	1.00E-03	1.00E-03
Brackish Water		2.00E-03	1.00E-03	3.00E-03	2.00E-03
City Water		1.00E-03	1.00E-03	2.00E-03	2.00E-03
Condensate		5.00E-04	5.00E-04	5.00E-04	5.00E-04
Cooling Tower	Treated MakeUp	1.00E-03	1.00E-03	2.00E-03	2.00E-03
	Untreated MakeUp	3.00E-03	3.00E-03	5.00E-03	4.00E-03
Distilled Water		5.00E-04	5.00E-04	5.00E-04	5.00E-04
Engine Jacket (Closed System)		1.00E-03	1.00E-03	1.00E-03	1.00E-03
Hard Water (Over 15 Grains/Gal)		3.00E-03	3.00E-03	5.00E-03	5.00E-03
Muddy Or Silty Water		3.00E-03	2.00E-03	4.00E-03	3.00E-03
River Water	Minimum	2.00E-03	1.00E-03	3.00E-03	2.00E-03
	Average	3.00E-03	2.00E-03	4.00E-03	3.00E-03
Sea Water		5.00E-04	5.00E-04	1.00E-03	1.00E-03
Spray Pond	Treated MakeUp	1.00E-03	1.00E-03	2.00E-03	2.00E-03
	Untreated MakeUp	3.00E-03	3.00E-03	5.00E-03	4.00E-03

CHEMICAL PROCESSING FOULING RESISTANCES/COEFFICIENTS		
Fouling Coefficient Units	Resistance ft ² h°F / Btu	
Gases & Vapors	Acid Gases	2.50E-03
	Stable Overhead Products	1.00E-03
	Solvent Vapors	1.00E-03
Liquids	Caustic Solutions	2.00E-03
	DEG And TEG Solutions	2.00E-03
	MEA And DEA Solutions	2.00E-03
	Stable Side Draw and Bottom Product	1.50E-03
	Vegetable Oils	3.00E-03

INDUSTRIAL FLUIDS FOULING RESISTANCES/COEFFICIENTS		
Fouling Coefficient Units	Resistance ft ² h°F / Btu	
Gases & Vapors	Ammonia Vapor	1.00E-03
	Chlorine Vapor	2.00E-03
	CO2 Vapor	1.00E-03
	Coal Flue Gas	1.00E-02
	Compressed Air	1.00E-03
	Engine Exhaust Gas	1.00E-02
	Manufactured Gas	1.00E-02
	Natural Gas Flue Gas	5.00E-03
	Refrigerant Vapors (Oil Bearing)	2.00E-03
	Steam (Exhaust, Oil Bearing)	1.80E-03
Steam (Non-Oil Bearing)	5.00E-04	
Liquids	Ammonia Liquid	1.00E-03
	Ammonia Liquid (Oil Bearing)	3.00E-03
	Calcium Chloride Solutions	3.00E-03
	Chlorine Liquid	2.00E-03
	CO2 Liquid	1.00E-03
	Ethanol Solutions	2.00E-03
	Ethylene Glycol Solutions	2.00E-03
	Hydraulic Fluid	1.00E-03
	Organic Heat Transfer Media	2.00E-03
	Methanol Solutions	2.00E-03
	Molten Heat Transfer Salts	5.00E-04
Refrigerant Liquids	1.00E-03	
Sodium Chloride Solutions	3.00E-03	
Oils	Engine Lube Oil	1.00E-03
	Fuel Oil #2	2.00E-03
	Fuel Oil #6	5.00E-03
	Quench Oil	4.00E-03
	Transformer Oil	1.00E-03

**APPENDIX VIII
LMTD CORRECTION FACTOR F_t**

**F_t Correction Factor for a 1 – n Heat Exchanger
(where n is even)**

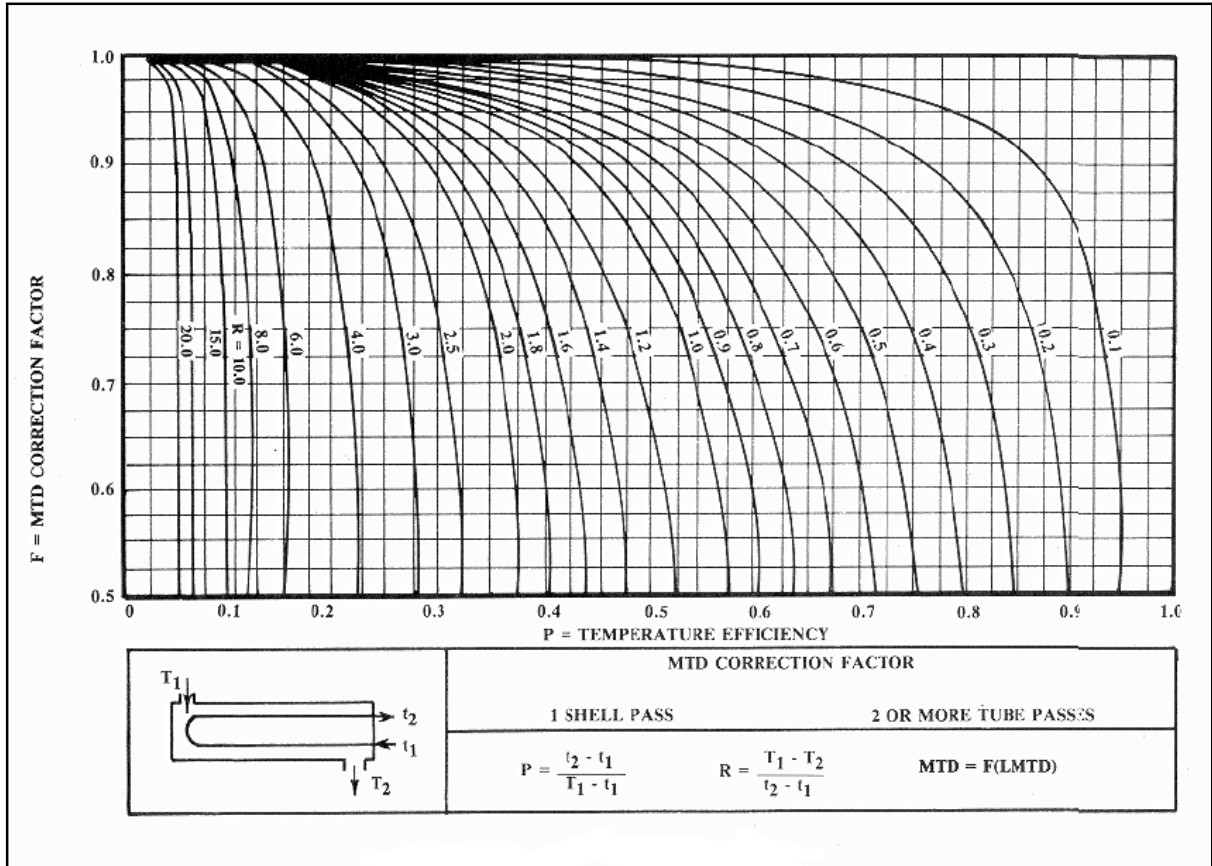

**APPENDIX IX
WOLVERINE TUBE GENERAL DETAILS**



S/T Trufin® - 11 Fins per Inch								
Standard Sizes			Plain End Dimensions		Finned Section Dimensions			
Catalog Number	Expanded End Nom. OD Inch (mm)	Nominal Wall Inch (mm)	Outside Diameter Inch (mm)	Wall Inch (mm)	Fin Height Inch (mm)	Maximum Fin OD Inch (mm)	Min. Wall Under Fins Inch (mm)	Root Diameter Inch (mm)
UNS C12200								
67-113028	5/8 (15.88)	0.028 (0.711)	0.500 (12.70)	0.063 (1.60)	0.125 (3.175)	0.628 (15.95)	0.023 (0.584)	0.375 (9.53)
67-113035	5/8 (15.88)	0.035 (0.889)	0.500 (12.70)	0.070 (1.78)	0.125 (3.175)	0.628 (15.95)	0.033 (0.826)	0.375 (9.53)
67-114025	3/4 (19.05)	0.025 (0.635)	0.625 (15.88)	0.063 (1.60)	0.125 (3.175)	0.753 (19.13)	0.023 (0.584)	0.500 (12.70)
67-114028	3/4 (19.05)	0.028 (0.711)	0.625 (15.88)	0.065 (1.65)	0.125 (3.175)	0.753 (19.13)	0.025 (0.635)	0.500 (12.70)
67-114035	3/4 (19.05)	0.035 (0.889)	0.625 (15.88)	0.070 (1.78)	0.125 (3.175)	0.753 (19.13)	0.026 (0.648)	0.500 (12.70)
67-115032	0.865 (21.97)	0.032 (0.813)	0.750 (19.05)	0.070 (1.78)	0.120 (3.048)	0.865 (21.97)	0.027 (0.686)	0.625 (15.88)
67-116038	1 (25.40)	0.038 (0.965)	0.875 (22.25)	0.075 (1.91)	0.125 (3.175)	1.003 (25.48)	0.035 (0.889)	0.750 (19.05)
UNS C70600								
67-113035	5/8 (15.88)	0.035 (0.889)	0.500 (12.70)	0.070 (1.78)	0.125 (3.175)	0.628 (15.95)	0.033 (0.826)	0.375 (9.53)
67-114035	3/4 (19.05)	0.035 (0.889)	0.625 (15.88)	0.072 (1.83)	0.125 (3.175)	0.750 (19.05)	0.033 (0.826)	0.500 (12.70)
67-115040	7/8 (22.23)	0.040 (1.016)	0.750 (19.05)	0.075 (1.91)	0.125 (3.175)	0.878 (22.30)	0.037 (0.940)	0.625 (15.88)
67-116044	1 (25.40)	0.044 (1.118)	0.875 (22.25)	0.083 (2.11)	0.125 (3.175)	1.003 (25.48)	0.041 (1.029)	0.750 (19.05)
67-118042	1.14 (31.75)	0.042 (1.067)	1.125 (28.58)	0.085 (2.16)	0.125 (3.175)	1.253 (31.83)	0.036 (0.914)	1.000 (25.40)

**APPENDIX X
MIDLAND WIRE CORDAGE TURBULATOR DETAILS**

The information presented here has been downloaded from www.midlandwirecordage.co.uk/htdivision

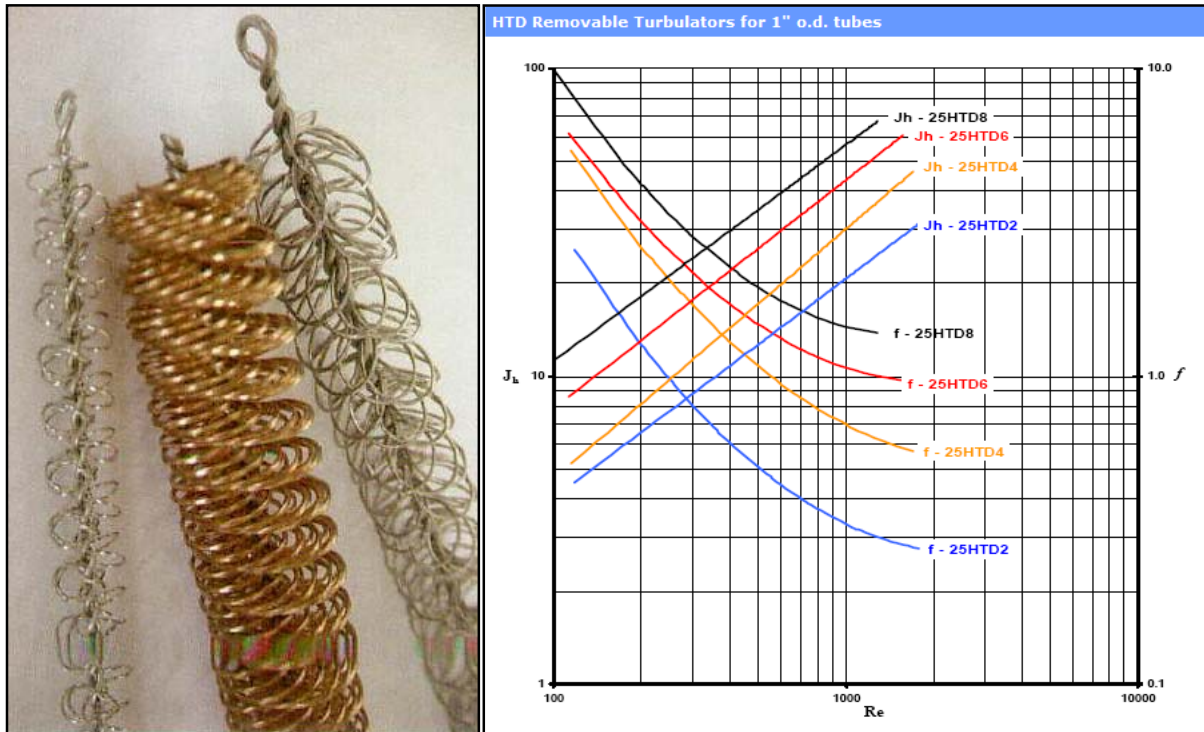

To calculate h_i for fluid flowing through tubes using HTD removable turbulators proceed as follows:

1. Obtain Reynolds Number in plain tube: $Re_i = (G_i \times D_i) / \mu$
2. Select insert to be considered in the design and use the appropriate performance curve to determine the values for heat transfer factor (J_H) and friction factor (f) corresponding to the Re_i value calculated in step 3

3. Calculate $h_i = J_H \times (k/D_i) \times Pr^{1/3} \times (\mu/\mu_w)^{0.14}$

4. Calculate pressure drop through tubes from:

$$\Delta P = (Z \times f \times L \times Np \times G_i^2) / (g \times \rho \times D_i \times (\mu/\mu_w)^{0.14})$$

Where $Z = 9.807 \times 10^{-5}$ for SI units, giving ΔP in bar

$Z = 5.36 \times 10^{-10}$ for English units, giving ΔP in lb/in²

5. Iterate design to optimise the relationship between through and over tubes performance, taking into account any variations of external surface which may be appropriate.

CC-THERM provides the facility for taking into account enhanced performance due to turbulators. Enter data under Tube specification or force the inside film coefficient by entering h_i determined in Step 3 above.

**APPENDIX XI
TUBE DIMENSIONAL DATA**

Tube OD	BWG	Thickness	Tube ID
in			in
0.5	12	0.109	0.282
	14	0.083	0.334
	16	0.065	0.370
	18	0.049	0.402
	20	0.035	0.430
0.75	10	0.134	0.482
	11	0.120	0.510
	12	0.109	0.532
	13	0.095	0.560
	14	0.083	0.584
	15	0.072	0.606
	16	0.065	0.620
	17	0.058	0.634
1	18	0.049	0.652
	8	0.165	0.670
	9	0.148	0.704
	10	0.134	0.732
	11	0.120	0.760
	12	0.109	0.782
	13	0.095	0.810
	14	0.083	0.834
	15	0.072	0.856
	16	0.065	0.870
1.25	17	0.058	0.884
	18	0.049	0.902
	8	0.165	0.920
	9	0.148	0.954
	10	0.134	0.982
	11	0.120	1.010
	12	0.109	1.032
	13	0.095	1.060
	14	0.083	1.084
	15	0.072	1.106
	16	0.065	1.120
	17	0.058	1.134
	18	0.049	1.152

**APPENDIX XII
SHELL TUBE COUNT DATA**

These tables are presented for thermal design guidance only. Perry 7th Edition and onwards have removed this table and show methods by calculation. In any event final layout is subject to detailed mechanical design.

TUBE SHEET TUBE HOLE COUNT (Perry Table 11-3)					
Table B 3/4od tubes on 15/16 triangular pitch					
Shell ID		TEMA L or M			
mm	in	Number of Passes			
		1	2	4	6
203	8	64	48	34	24
254	10	85	72	52	50
305	12	122	114	94	96
337	13.25	151	142	124	112
387	15.25	204	192	166	168
438	17.25	264	254	228	220
489	19.25	332	326	290	280
540	21.25	417	396	364	348
591	23.25	495	478	430	420
635	25	579	554	512	488
686	27	676	648	602	584
737	29	785	762	704	688
787	31	909	878	814	792
838	33	1035	1002	944	920
889	35	1164	1132	1062	1036
940	37	1304	1270	1200	1168
991	39	1460	1422	1338	1320
1067	42	1703	1664	1578	1552
1143	45	1960	1918	1830	1800
1219	48	2242	2196	2106	2060
1372	54	2861	2804	2682	2660
1524	60	3527	3476	3360	3300
1676	66	4292	4228	4088	4044
1829	72	5116	5044	4902	4868
1981	78	6034	5964	5786	5740
2134	84	7005	6934	6766	6680
2286	90	8093	7998	7832	7708
2438	96	9203	9114	8896	8844
2743	108	11696	11618	11336	11268
3048	120	14459	14378	14080	13984

MAXIMUM UNSUPPORTED SPAN (Hewitt Table 6.1) TUBE MATERIALS and TEMPERATURE LIMITS(degC)			
Tube OD mm	Carbon/High Alloy Steel	(400)	Aluminium & Al Alloys Copper & Copper Alloys Titanium & Zirconium
	Low Alloy Steel	(454)	
	Nickel-Copper	(316)	
	Nickel	(454)	
	Nickel-Chromium-Iron	(538)	
19		1520	1321
25		1880	1626
32		2240	1930
38		2540	2210
50		3175	2794